

MT6 LIVE CENTRE FITTED WITH STANDARD TIP

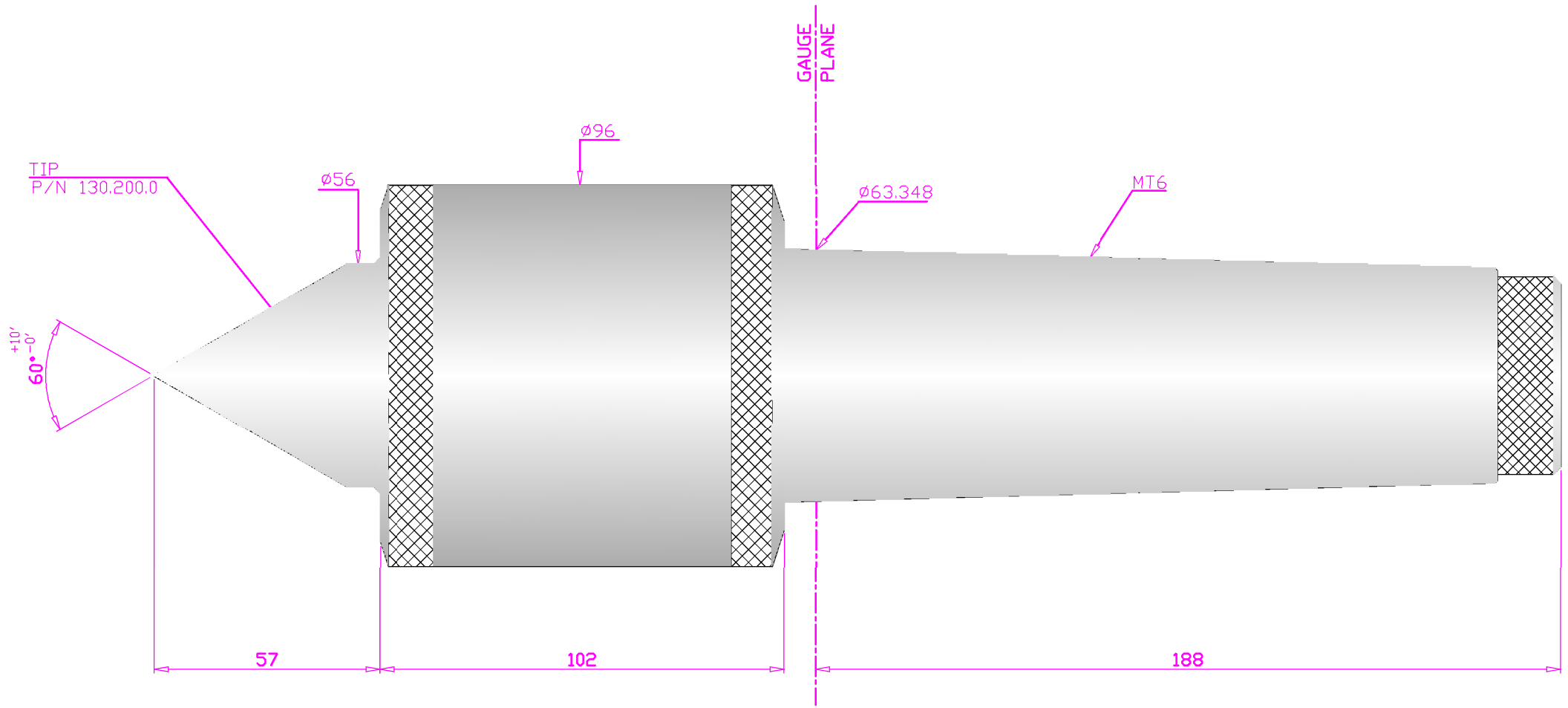

MAX. RUN-OUT	MAX. RPM	HARDNESS OF TIP	HARDNESS OF SHANK
0.015 mm	4500	60-63 HRC	32-40 HRC